



KIESELMANN

FLUID PROCESS GROUP

Translation of the original

Operating Instructions

Pneumatic multiturn actuators

Type 4x00

pneumatic - mechanical
for butterfly valves and ball valves

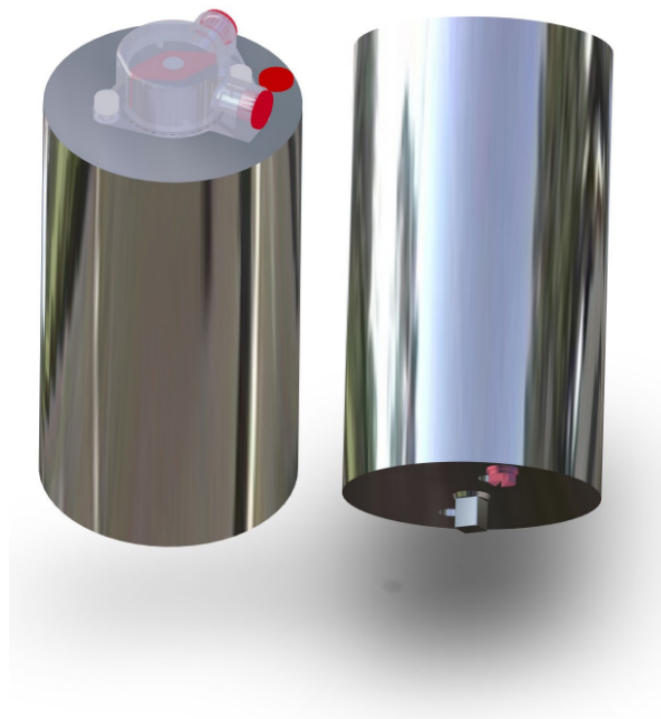

KIESELMANN GmbH

Paul-Kieselmann-Str. 4-10
D - 75438 Knittlingen

 +49(0) 7043 371-0 •  +49(0) 7043 371-125
www.kieselmann.de • info@kieselmann.de

Copyright: © KIESELMANN FLUID PROCESS GROUP

Table of contents

1	General informations	4
1.1	Informations for your safety	4
1.2	Marking of security instructions	4
1.3	General designated use	4
1.4	Personnel	4
1.5	Modifications, spare parts, accessories	5
1.6	General instructions	5
2	Safety instructions	6
2.1	Intended use	6
2.2	General notes	6
2.3	General safety instructions	6
3	Delivery, transport and storage	7
3.1	Delivery	7
3.2	Transport	7
3.3	Storage	7
4	Function and operation	8
4.1	Description of function	8
4.2	Control system and position indication	9
5	Commissioning, service and maintenance	10
5.1	Commissioning	10
5.1.1	Installation instructions	10
5.1.2	General welding guidelines	10
5.1.3	ATEX - Guidelines	10
5.2	Service	11
5.3	Cleaning	11
6	Technical data	12
6.1	Multiturn actuators	12
6.2	Torques	13
7	Dimensions	15
8	Wearing parts	16
8.1	Spare parts list	16
9	Appendix	17
9.1	Declaration of incorporation	17

1 General informations

1.1 Informations for your safety

We are pleased that you have decided for a high-class KIESELMANN product. With correct application and adequate maintenance, our products provide long time and reliable operation.





Before installation and initiation, please carefully read this instruction manual and the security advices contained in it. This guarantees reliable and safe operation of this product and your plant respectively. Please note that an incorrect application of the process components may lead to great material damages and personal injury.

In case of damages caused by non observance of this instruction manual, incorrect initiation, handling or external interference, guarantee and warranty will lapse!

Our products are produced, mounted and tested with high diligence. However, if there is still a reason for complaint, we will naturally try to give you entire satisfaction within the scope of our warranty. We will be at your disposal also after expiration of the warranty. In addition, you will also find all necessary instructions and spare part data for maintenance in this instruction manual. If you don't want to carry out the maintenance by yourself, our KIESELMANN - service team will naturally be at your disposal.

1.2 Marking of security instructions

Hints are available in the chapter "safety instructions" or directly before the respective operation instruction. The hints are highlighted with a danger symbol and a signal word. Texts beside these symbols have to be read and adhered to by all means. Please continue with the text and with the handling at the valve only afterwards.

Symbol	Signal word	Meaning
	DANGER	Imminent danger which will result severe personal injury or death.
	WARNING	Imminent danger which may result severe personal injury or death.
	CAUTION	Dangerous situation which may cause slight personal injury or material damages.
	NOTICE	An harmful situation which may result in damages of the product itself or of adjacent vicinity.
	INFORMATION	Marks application hints and other information which is particularly useful.

1.3 General designated use

The fitting is designed exclusively for the purposes described below. Using the fitting for purposes other than those mentioned is considered contrary to its designated use. KIESELMANN cannot be held liable for any damage resulting from such use. The risk of such misuse lies entirely with the user. The prerequisite for the reliable and safe operation of the fitting is proper transportation and storage as well as competent installation and assembly. Operating the fitting within the limits of its designated use also involves observing the operating, inspection and maintenance instructions.

1.4 Personnel

Personnel entrusted with the operation and maintenance of the tank safety system must have the suitable qualification to carry out their tasks. They must be informed about possible dangers and must understand and observe the safety instructions given in the relevant manual. Only allow qualified personnel to make electrical connections.

1.5 Modifications, spare parts, accessories

Unauthorized modifications, additions or conversions which affect the safety of the fitting are not permitted. Safety devices must not be bypassed, removed or made inactive. Only use original spare parts and accessories recommended by the manufacturer.

1.6 General instructions

The user is obliged to operate the fitting only when it is in good working order. In addition to the instructions given in the operating manual, please observe the relevant accident prevention regulations, generally accepted safety regulations, regulations effective in the country of installation, working and safety instructions effective in the user's plant.

2 Safety instructions

2.1 Intended use

The pneumatic multiturn actuator can be used for rotary fittings in the beverages and foodstuffs industry, the pharmaceuticals industry and the bio-technology sector, as well as the chemical industry.

2.2 General notes



NOTICE - observe the operating instructions

To avoid danger and damage, the fitting must be used in accordance with the safety instructions and technical data contained in the operating instructions.



NOTICE

All data are in line with the current state of development. Subject to change as a result of technical progress.

2.3 General safety instructions



⚠ WARNING

Risk of injury by pre-stressed pressure spring.

The pneumatic-mechanical actuator is spring-loaded. When disassembling the actuator, components that jump out may cause injuries.

- Multiturn actuators are maintenance-free and therefore do not need to be opened!



⚠ WARNING

ATEX - Guidelines

If the valve or the plant is operated in a potentially explosive atmosphere, the valid ATEX directive of the EC and the installation instructions in this operating manual must be observed.



⚠ CAUTION

To avoid air leaking, only use pneumatic connection parts that have an O-ring seal facing the even surface.



⚠ CAUTION

Steps should be taken to ensure that no external forces are exerted on the fitting.

3 Delivery, transport and storage

3.1 Delivery

Immediately after receipt check the delivery for completeness and transport damages.

Remove the packaging from the product.

Retain packaging material, or expose of according to local regulations.

3.2 Transport



CAUTION

Risk of injury and damage to the product

During the transport the generally acknowledged rules of technology, the national accident prevention regulations and company internal work and safety regulations must be observed.

3.3 Storage



NOTICE

Damage to the product due to improper storage!

Observe storage instructions

avoid a prolonged storage



INFORMATION

Recommendation for longer storage

We recommend regularly checking the product and the prevailing storage conditions during long storage times.

- To avoid damage to seals and bearings,
 - products up to DN 125 / OD 5 inch should be stored horizontally for maximum 6 months.
 - products larger than DN 125 / 5 inch, should be stored in the upright position with the actuator on top.
- Don't store any objects on the products.
- Protect the products for wetness, dust and dirt.
- The product should be stored in a dry and well ventilated room at a constant temperature (optimal indoor temperature: 25 C ±5; indoor humidity data 70% ±5%).
- Protect seals, bearings and plastic parts for UV light and ozone.

4 Function and operation

4.1 Description of function



air open- spring close (NC)

If compressed air is connected to the air connection port LA1 of the multiturn actuator, its axis will turn 90° clockwise. When bleeding it will reset by spring force.

air open - air close (DA)

If compressed air is connected to the air connection port LA1 or LA2 of the multiturn actuator, its axis will turn 90°.



INFORMATION

- To make sure that the rotary movement really stops at 0°-90° or 90°-0°, make sure to bleed the compressed air port of the rotary drive not being used.
- In order to avoid air leakages, only use an elbow-type screw-in connexion respectively a straight screw-in connexion with sealing by an o-ring to the end face.

The multiturn actuator is used for the following products:

- Butterfly valves (BV) and Leakage butterfly valves (LBV)
- Straight way ball valve (SWBV) and Three-way ball valve (TWBV)

Actuator	Item number	BV	LBV	SWBV	TWBV
90 / 75					
lö-fs (air/spring)	4200 075 000-022	DN15/40	-	DN10/40	-
90 / 100					
lö-ls (air/air)	4100 100 000-022	DN25/100	DN50/80	DN25/80	DN25/65
lö-fs air/spring)	4200 100 000-022	DN25/100	DN50/80	DN25/80	DN25/65
90 / 125					
lö-ls (air/air)	4100 125 000-022	DN125/150	DN100/150	DN100	DN80/100
lö-fs air/spring)	4200 125 000-022	DN125/150	DN100/150	DN100	DN80/100

lö = air open; ls = air close; fs = spring close; fö = spring open

4.2 Control system and position indication



Feedback unit -optional-

Optionally, modular valve control head systems can be installed to the actuator for reading and actuating valve positions. The standard version is a closed system with SPS or ASI-bus switch-on electronics, and integrated 3/2-way solenoid valves. For tough operating conditions we recommend employing a high-grade steel cover.

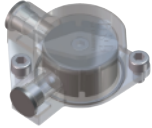

Position indicator with sensor mounting for feedback signal.

The actuator is equipped with a proximity switch mounting (sensor mounting) and a position indication. When inductive proximity initiators M 12x1 are installed, the current "Open" or "Shut" position can be interrogated. By screwing the proximity initiator to the limit position the required switching gap for the signal transmission is established.. When the valve is closed the position indication is oriented vertically to the direction of valve passage. When the valve is open it is oriented parallel to the valve passage.

Standard equipment of the multiturn actuator (A) includes a position indication.



NOTICE

- To prevent leaks, the thread needs to be sealed with a gasket strip when installing the proximity switches.

Proximity switches (Sensors)

The transparent hood (R5) is suitable for commercially available inductive proximity switches (sensors) with thread M12x1. Use proximity switches with non-flush mounting and a nominal operating distance of min. 4.0 mm.

The proximity initiators in different variants can be obtained from KIESELMANN.

Before mounting proximity switches first remove the red plastic caps (R6) from the hood (R5). Then manually screw the proximity switches into the threaded holes of the hood until they arrive at the stop. No adjustment will be required. Counter with a lock nut the switch against the hood (R5) applying little force.

For valve maintenance you may screw the hood (R5) off the drive unit together with the proximity switches.

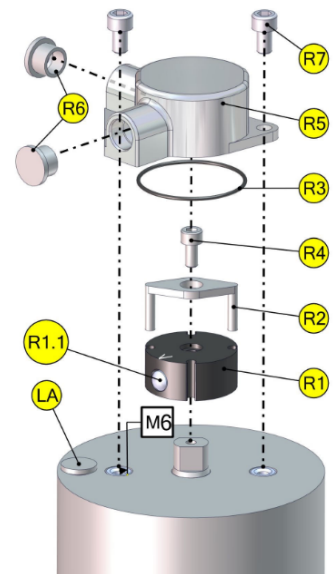

- Position indication with sensor mounting (R)

R1	dog	R4	Screw
R1.1	cylinder pin	R5	Cap
R2	Position indication	R6	Cap
R3	O-ring	R7	Screw
		LA	Air supply

5 Commissioning, service and maintenance

5.1 Commissioning

5.1.1 Installation instructions

Fitting position - Multiturn actuator 90/75

The multiturn actuator should be installed vertically.

Fitting position - Multiturn actuator 90/100 and 90/125

The installation position is without importance. However, there may be valve-specific restrictions.



NOTICE

Risk of shock pressure

You may have to restrict the pressure of the outlet air to avoid shock pressure.



NOTICE

Damage due to impurities

Impurities can cause damage to the seals and seals area.

Clean inside areas prior to assembly.

5.1.2 General welding guidelines

Sealing elements integrated in weld components must generally be removed prior to welding. To prevent damage, welding should be undertaken by certified personnel (EN ISO 9606-1). Use the TIG (Tungsten Inert Gas) welding process.



CAUTION

Damage and injuries due to high temperature supply

To avoid a distortion of the components, all welding parts must be welded to stress-relieved.

Allow all components to cool before assembling.



NOTICE

Damage due to impurities

Impurities can cause damage to the seals and seals area.

Clean inside areas prior to assembly.

5.1.3 ATEX - Guidelines

For valves or plants/installations that are operated in the ATEX area, sufficient bonding (grounding) must be ensured (see valid ATEX Guidelines EG).

5.2 Service

The actuators are maintenance-free and non-removable.

Lubricant recommendation

	EPDM; HNBR; NBR; FKM; k-flex	-	Klüber Paraliq GTE703*
	Silicone	-	Klüber Sintheso pro AA2*
	Thread	-	Interflon Food*
*) It is only permitted to use approved lubricants, if the respective fitting is used for the production of food or drink. Please observe the relevant safety data sheets of the manufacturers of lubricants.			

5.3 Cleaning

The cleaning of the external surfaces must be performed at regular intervals. The cleaning cycles are to be defined by the user.

6 Technical data

6.1 Multiturn actuators

Model:	Multiturn actuators, pneumatical enclosed type		
Kind of actuation:	air / air (double action) air / spring (single action)		
Angle of rotation:	90° (+3°)		
Valve size:	Actuator 90 / 75 Actuator 90 / 100 Actuator 90 / 125		
Temperature range:	Ambient temperature: +4 to +60°C (air)		
Air supply:	G 1/8		
Leak rate:	A (DIN EN 12266-1)		
Control air:	<u>Control air pressure:</u> 5,5 - 8,0 bar	<u>Quality of control air:</u> ISO 8573-1 : 2001 quality class 3	
Materials: (in product contact)	Stainless steel:	1.4301 / AISI304	
	Surfaces:	Ra < 1,5 - 2,5µm e-polished	
	Sealing material:	NBR	
Air requirement per stroke: (at atmospheric pressure)	Actuator 90 / 75	air / spring	- 0,20 litre/bar
	Actuator 90 / 100		- 0,50 litre/bar
Actuator 90 / 125	- 0,70 litre/bar		
	Actuator 90 / 100	air / air	- 1,30 litre/bar
	Actuator 90 / 125		- 1,90 litre/bar

6.2 Torques

Actuator 90/75

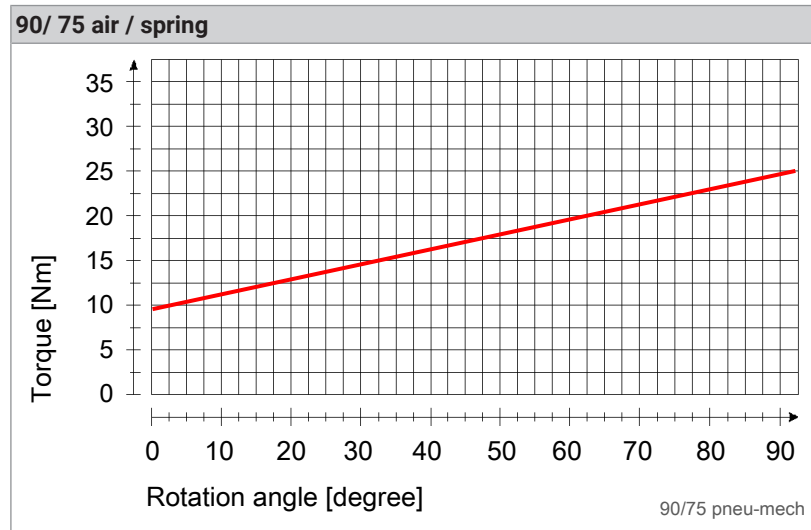

Actuator 90/100

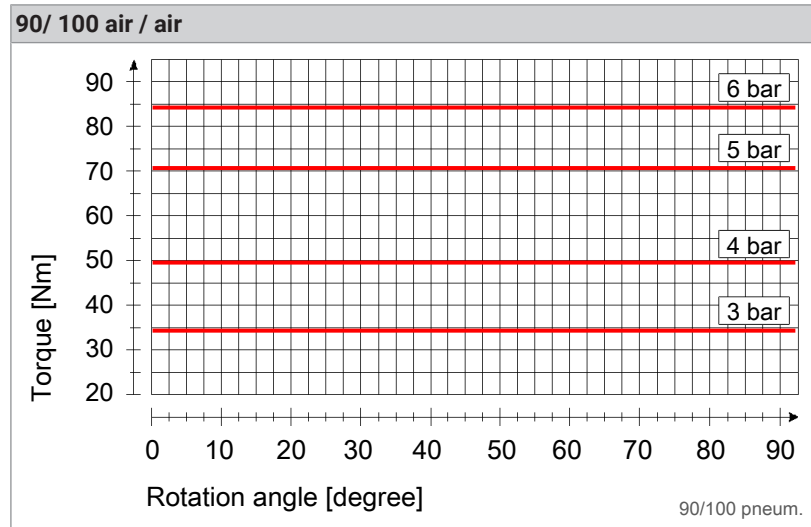
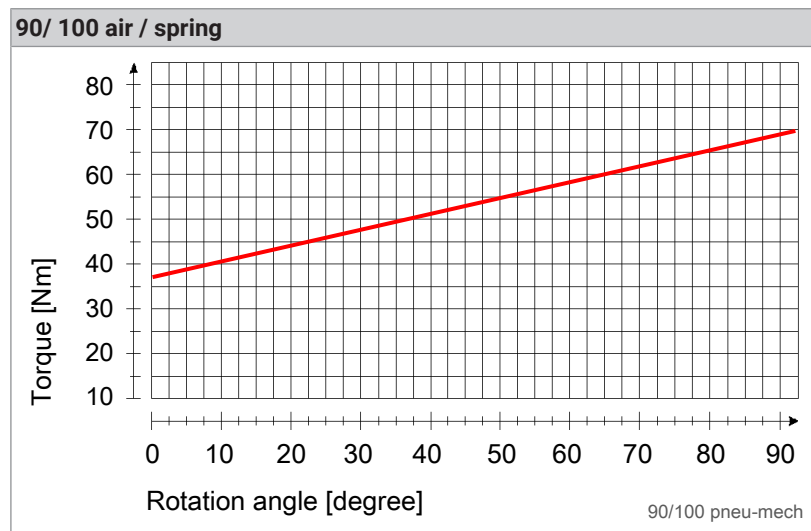

Actuator 90/125

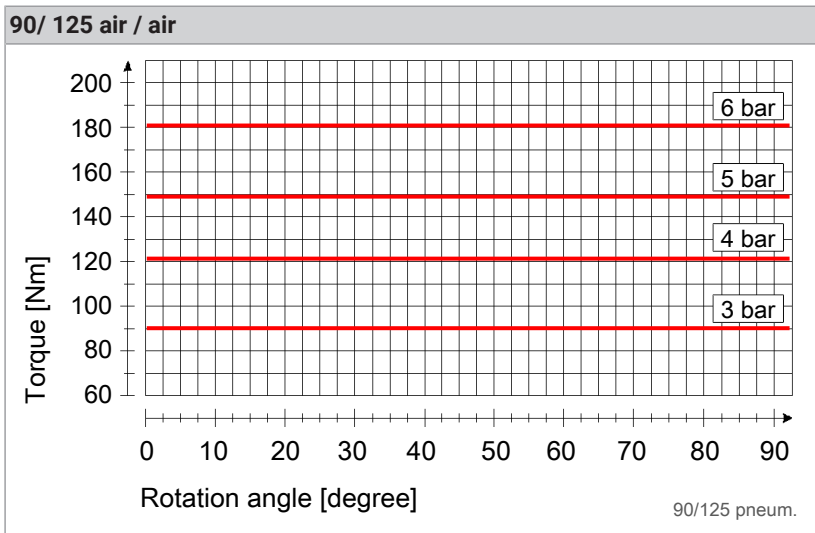
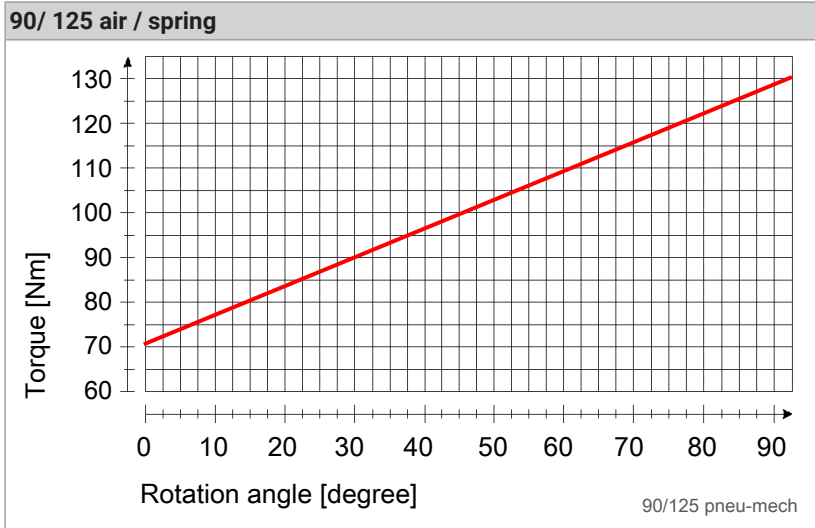

7 Dimensions

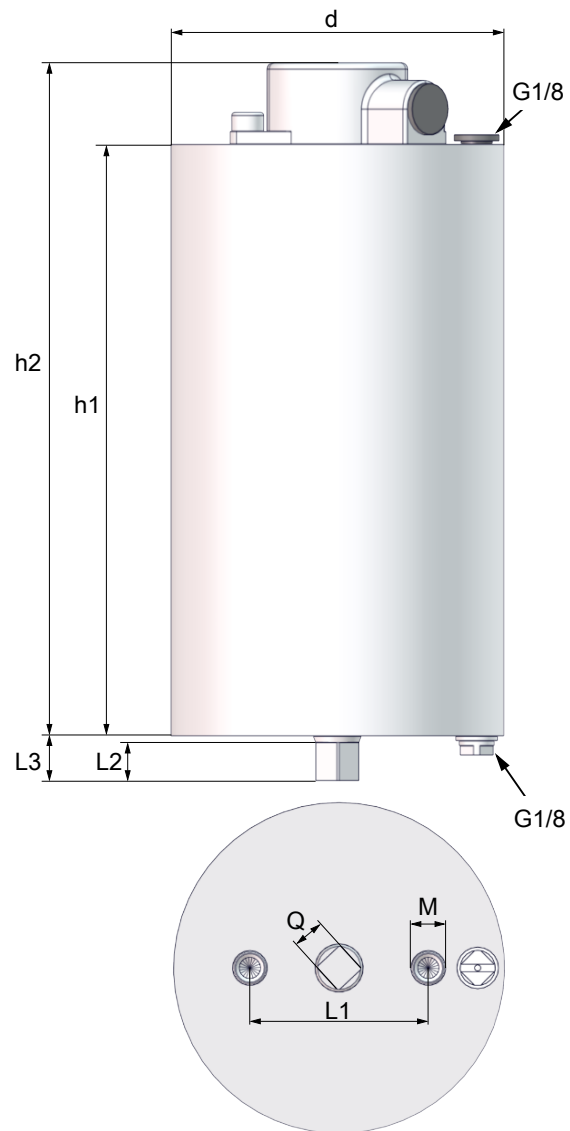

	Pneum. actuator		
	90 / 75	90 / 100	90 / 125
d	76	104	129
h1	142.5	186	215
h2	168	211.5	240.5
L1	56	56	78
L2	12	12	16
L3	14	14	20
M	M8	M8	M8
Q	10	10	14



8 Wearing parts

8.1 Spare parts list

Actuator

Pneum. actuator	Type	Item number	Material
90 / 75 (Ø 75)	lö-fs (air/spring)	4200 075 000-022	AISI 304
	lö-fs (air/spring) with position indication	4200 075 100-022	
90 / 100 (Ø 104)	lö-ls (air/air)	4100 100 000-022	AISI 304
	lö-ls (air/air) with position indication	4100 100 100-022	
	lö-fs (air/spring)	4200 100 000-022	
	lö-fs (air/spring) with position indication	4200 100 100-022	
90 / 125 (Ø 125)	lö-ls (air/air)	4100 125 000-022	AISI 304
	lö-ls (air/air) with position indication	4100 125 100-022	
	lö-fs (air/spring)	4200 125 000-022	
	lö-fs (air/spring) with position indication	4200 125 100-022	

Position indication (R) complete

Valve type	Item number	Position
<ul style="list-style-type: none"> • Butterfly valves • Leakage - butterfly valves • Straight way ball valve 	4100 100 020-000	R1.1 
<ul style="list-style-type: none"> • Three-way ball valve with L-ball 	4100 100 047-000	R1.1 
<ul style="list-style-type: none"> • Three-way ball valve with T-ball 	4100 100 040-000	R1.1 

Pos.	Designation	Item number	Material	pce.
R1	dog	4100 100 023-097	PBT sw	1
R1:1	cylinder pin	8062 081 008-020	AISI 304	1
R2	Position indication	4100 100 024-093	PS rt	1
R3	O-ring	2304 040 015-055	NBR 70°Sh.	1
R4	Allen screw	8095 005 010-020	AISI 304	1
R5	Cap	4100 100 021-094	MAPS	1
R6	Cap	4301 080 020-095	GPN 300/F091	2
R7	Allen screw	8095 006 010-020	AISI 304	2

9 Appendix

9.1 Declaration of incorporation



Declaration of incorporation

Translation of the original

Manufacturer / authorised representative:

KIESELMANN GmbH

Paul-Kieselmann-Str. 4-10

75438 Knittlingen

Germany

Authorised representative:

(for compiling technical documents)

Achim Kauselmann

(Documentation / Development)

KIESELMANN GmbH

Paul-Kieselmann-Str. 4-10

75438 Knittlingen

Germany

<u>Product name</u>	<u>Function</u>
pneum. Lift actuators	Stroke movement
pneum. Rotary actuators	Rotary movement
Ball valves	Media cutoff
Butterfly valves	Media cutoff
Single seat valves	Media cutoff
Flow control valves	Control of liquefied media
Throttle valve	Control of liquefied media
Overflow valve	Definition of fluid pressure
Double seat valve	Media separation
Bellow valves	Sampling of liquids
Sampling valves	Sampling of liquids
Two way valves	Media cutoff
Tankdome fitting	Prevention of overpressure and vacuum, Tank cleaning
Safety valve	Prevention of overpressure

The manufacturer hereby states that the above product is considered as an incomplete machine in the sense defined in the Directive 2006/42/EC on Machinery. The above product is exclusively intended to be installed into a machine or an incomplete machine. The said product does not yet conform to all the relevant requirements defined in the Directive on Machinery referred to above for this reason.

The specific technical documents listed in Appendix VII, Part B, have been prepared. The Authorized Agent empowered to compile technical documents may submit the relevant documents if such a request has been properly justified.

Commissioning of an incomplete machine must not only be carried out if it has been determined that the respective machine into which the incomplete machine is to be installed conforms to the regulations set out in the Directive on Machinery referred to above.

The above product conforms to the requirements of the directives and harmonized standards specified below:

- Directive 2014/68/EU
- EN ISO 12100 Safety of machinery

Knittlingen, 21.09.2017

i.V. Uwe Heisswolf
Head of Development

